

◆ ATELIER FORTVNY VENEZIA ◆

produced & distributed by Fortuny S.r.l. San Marco, 2425 - 30124 Venezia - Italy p+39 041 5236953 . info@fortuny.it
www.fortuny.it

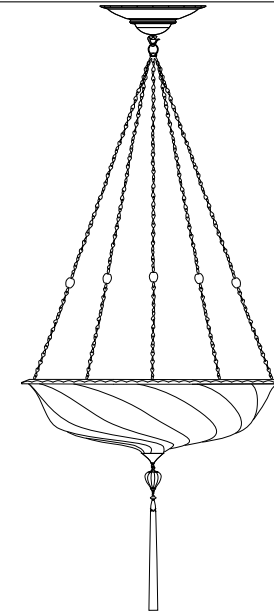

SCUDO SARACENO / art. G 055 SA / glass

assembly instructions / suspended

LED | 1 x MAX 15W | E26 | 110-120V | 50-60 Hz



ATTENTION: do not use abrasive products to clean this lamp but only a damp cloth.

Our creations may show slight imperfections due to the special handwork required on each piece. Variations are one of the features which make each of our products an original and unique item.

WARNING: the safety is guaranteed only with appropriate use of these instructions, which must be kept for future reference. We recommend the installation by qualified personnel.

GENERAL:

- Read all instructions and review diagrams beginning with the installation of the fixture.
- All electrical connections must be in accordance with local codes, ordinances or national codes. If you are unfamiliar with methods of electrical wiring, secure the services of a qualified licensed electrician.

BEFORE BEGINNING INSTALLATION:

- Turn off the electricity to the outlet box at the circuit breaker or fuse box.
- If you are replacing an existing fixture, remove the old fixture and expose the supply wiring.
- Remove the old cross bar.

ELECTRICAL CONNECTIONS:

- While supporting the fixture, connect the white wire from the fixture to the white or marked wire of the supply circuit.
- Connect the black fixture to the black supply wire. Connect the ground wire - bare copper wire - to the ground conductor of the supply circuit. Secure with UL listed wire connectors suitable for the size, type and number of wires. Make sure that there are no loose strands of wire and that there are no loose connections.
- Spread the electrical wire connections apart and back into the outlet box.

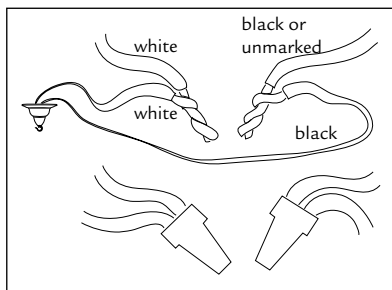

INSTALLING FIXTURE:

1. Before starting the installation, disconnect the power by turning off the circuit breaker or removing the fuse at the fuse box.
2. Attach the cross bar **A** to the outlet box using the outlet box screws.

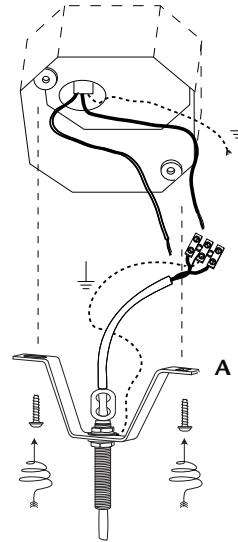

3. Make the electrical connections. Refer to the section titled Electrical Connections.
4. Place the canopy (element **B**) over the nipple.

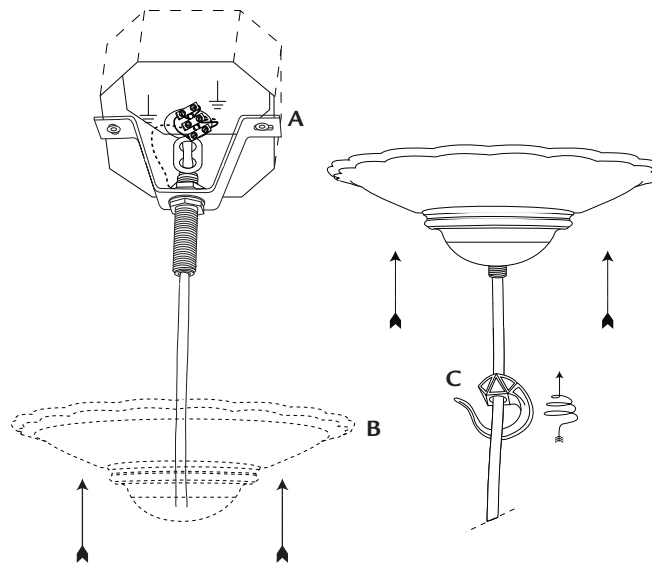

5. Screw the hook **C** onto the nipple and tighten securely.

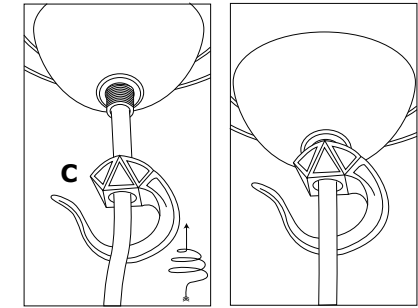

6. Install bulb. Do not exceed the maximum wattage for this fixture. Refer to the wattage warning label attached to the fixture for maximum allowable wattage.
7. You can now hang the metal disk.
8. Restore the electricity and test.

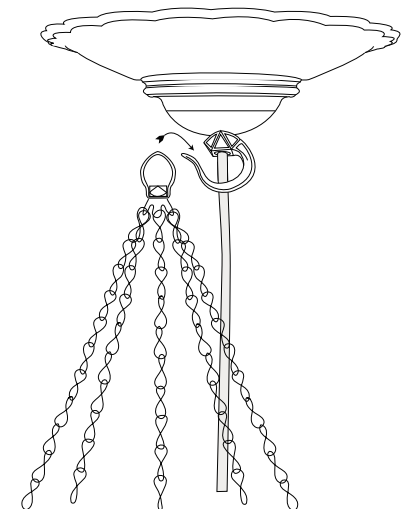

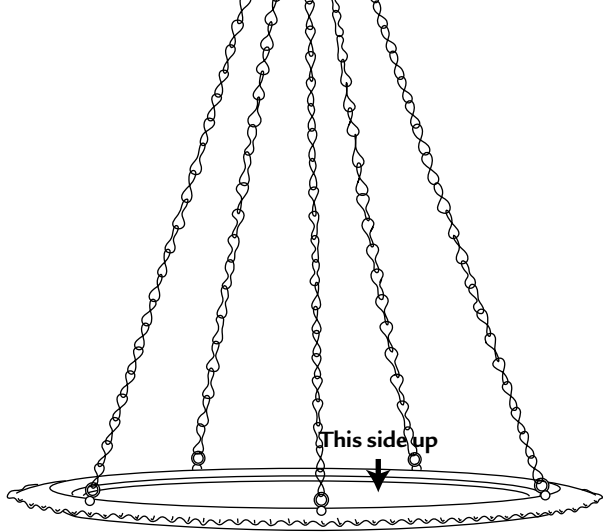

A

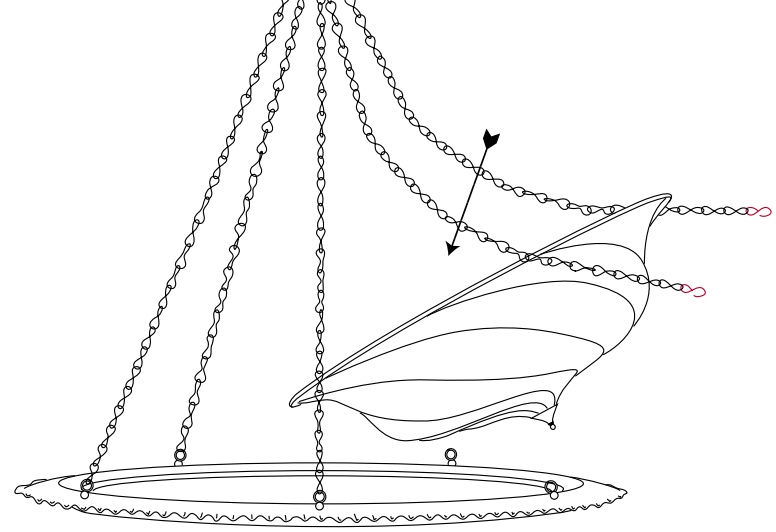

B. Insert the lampshade through the chains as shown in the picture.

C. Delicately push lampshade down until it is firmly secured to the frame.

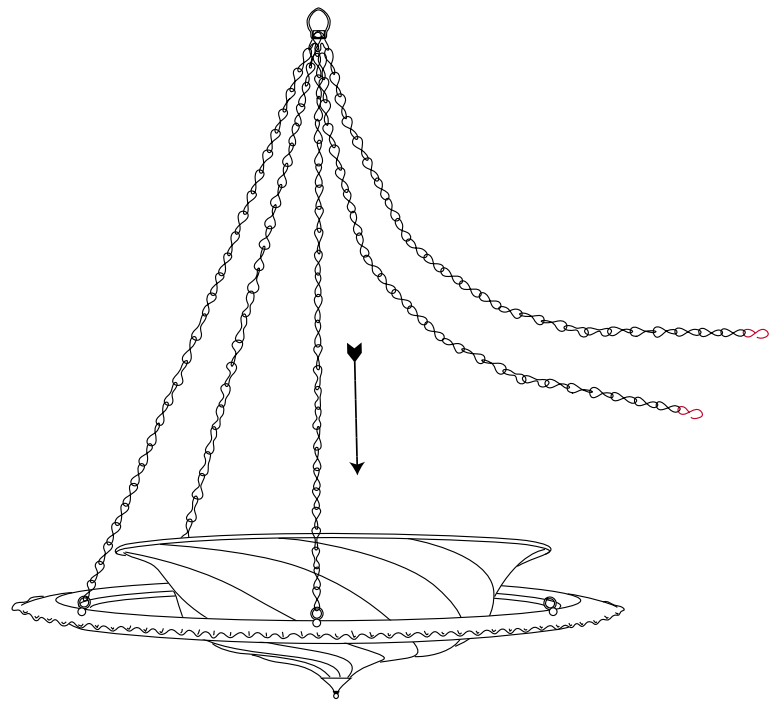

D. Please note: if the length of the chains is minimal you will find the chains dropped from the frame (as shown in the pictures). After you insert the lamp you must hang up the chains and close the last ring with pliers.

